

# Dalla prima pietra al tetto.

WordPress per Principianti:  
Costruisci la tua casa digitale.

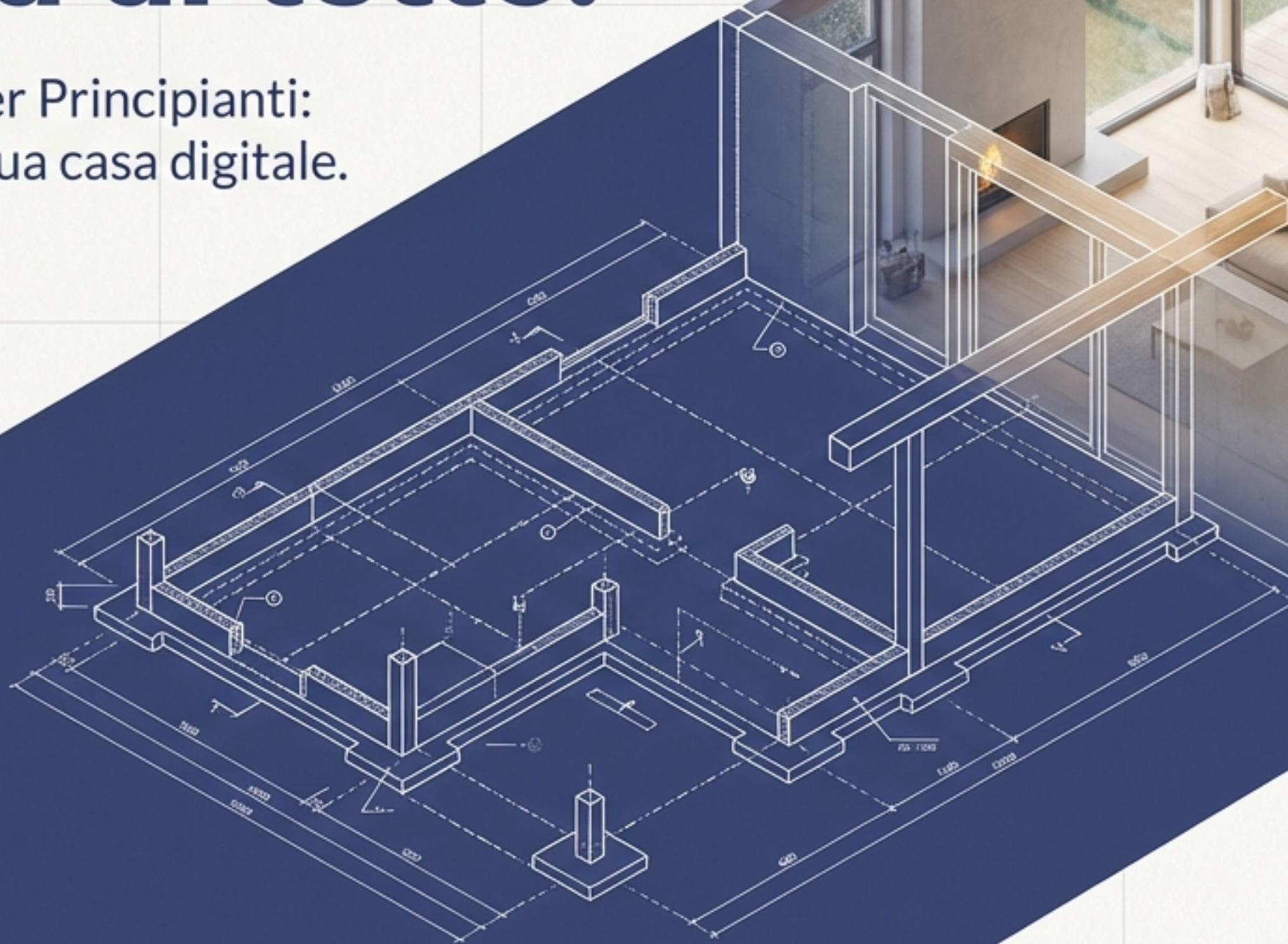

# Perché costruire qui?



**Open Source**: Il software è tuo.  
Nessun affitto, massima libertà.



**La Missione**: Creare un sito  
professionale che possiedi al 100%.



**Versatilità**: Ideale per blog, siti  
aziendali e portfolio.

SCOPRI DI PIÙ

# Fase 1: Il Terreno e l'Indirizzo

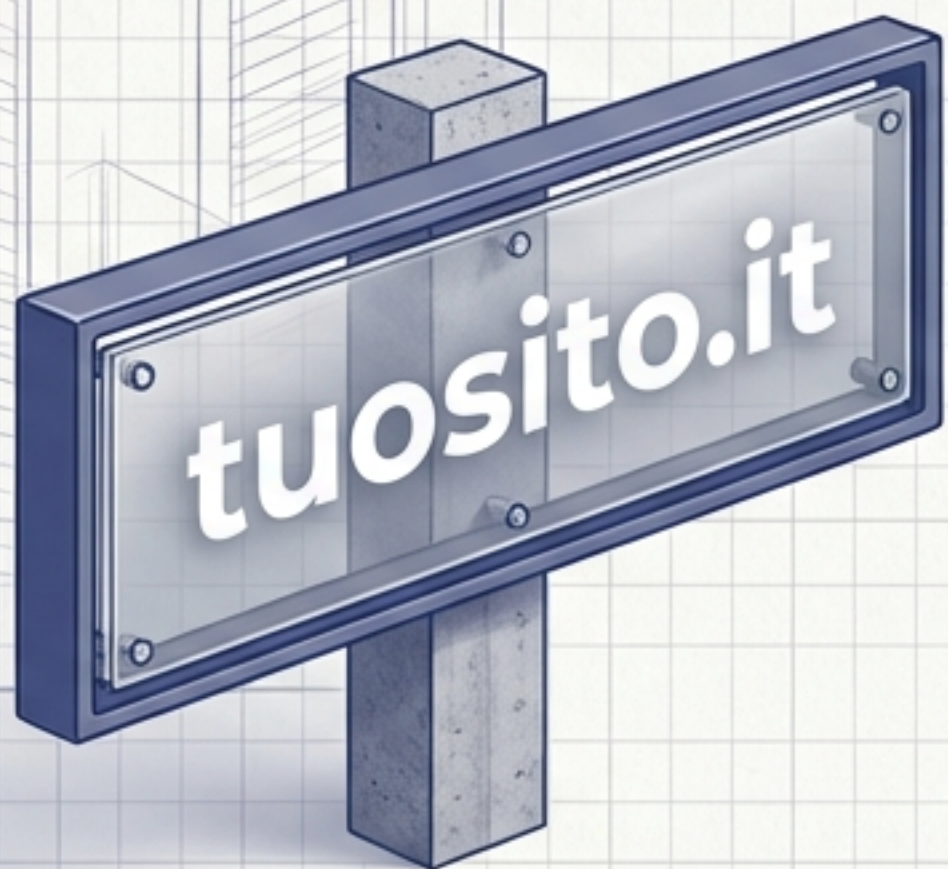

**L'Indirizzo (Nome di Dominio)**



**Il Terreno (Hosting Web)**

- **WordPress.com** = Appartamento in affitto (Limitato)
- **WordPress.org** = Casa di proprietà (Tua per sempre)

# Entriamo in cantiere



1. Accedi al cPanel



2. Clicca Softaculous



3. Installazione in 5 minuti

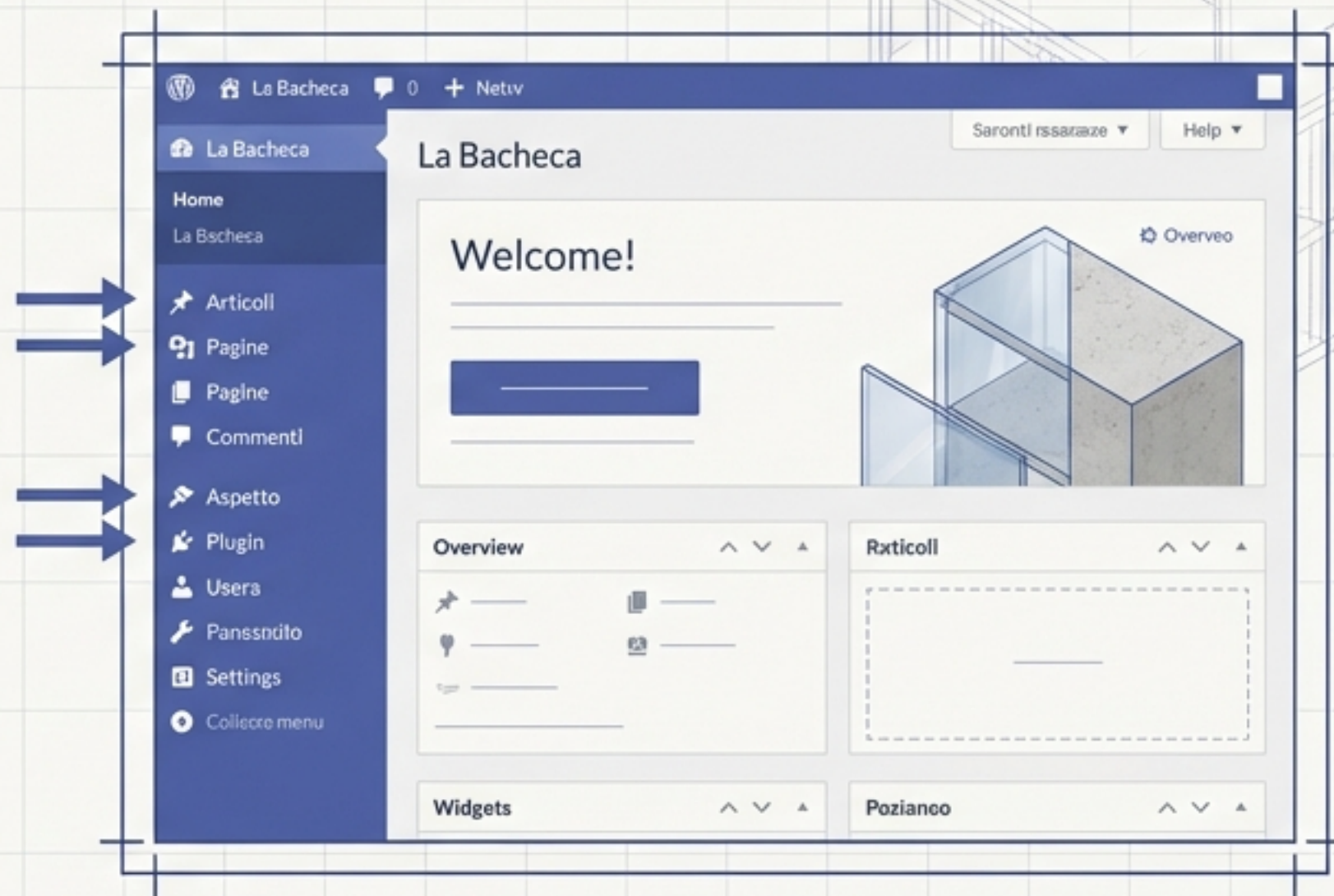

[tuosito.it/wp-admin](https://tuosito.it/wp-admin)

# Le fondamenta strutturali

## CHECKLIST

- 1. Generali:  
Titolo, Motto e Fuso orario.
- 2. Lettura: Homepage statica  
o Ultimi articoli.
- 3. PERMALINK: Imposta  
su "Nome articolo".

Essenziale per la SEO  
(tuosito.it/nome-pagina)

# Muri portanti e stanze dinamiche

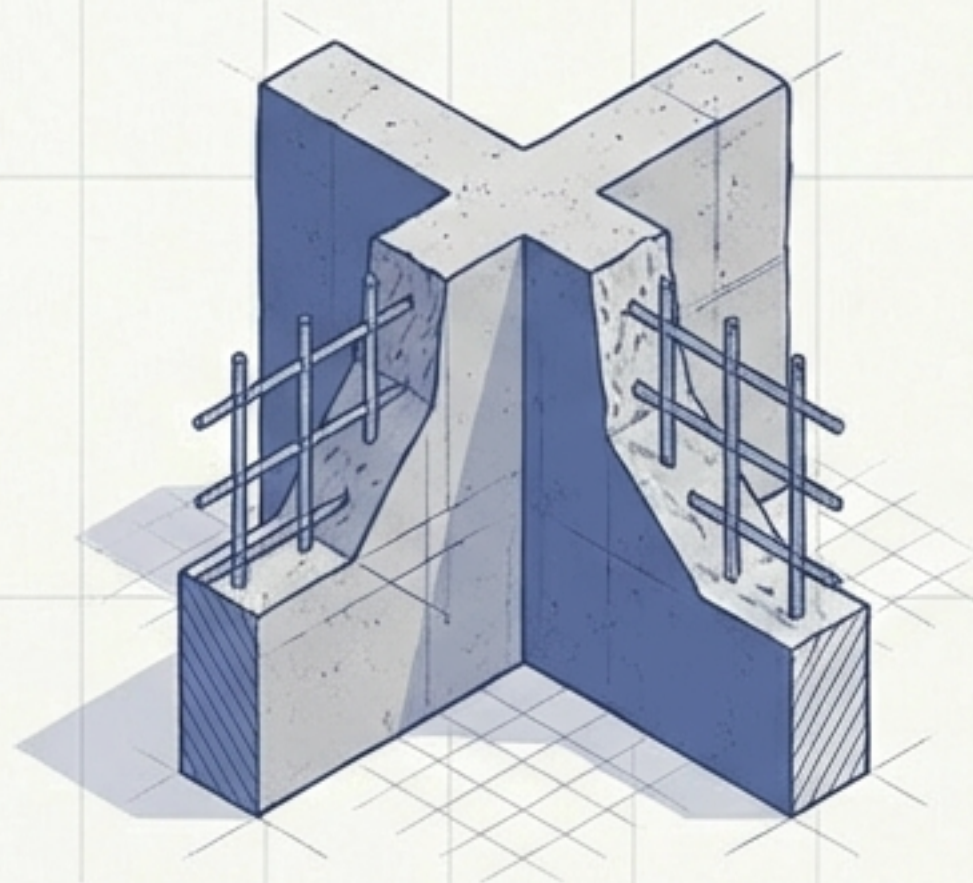

**Pagine**  
(Statiche)

Chi siamo  
Contatti  
Servizi

**Articoli**  
(Dinamici)

Blog Post  
Categorie  
Tag

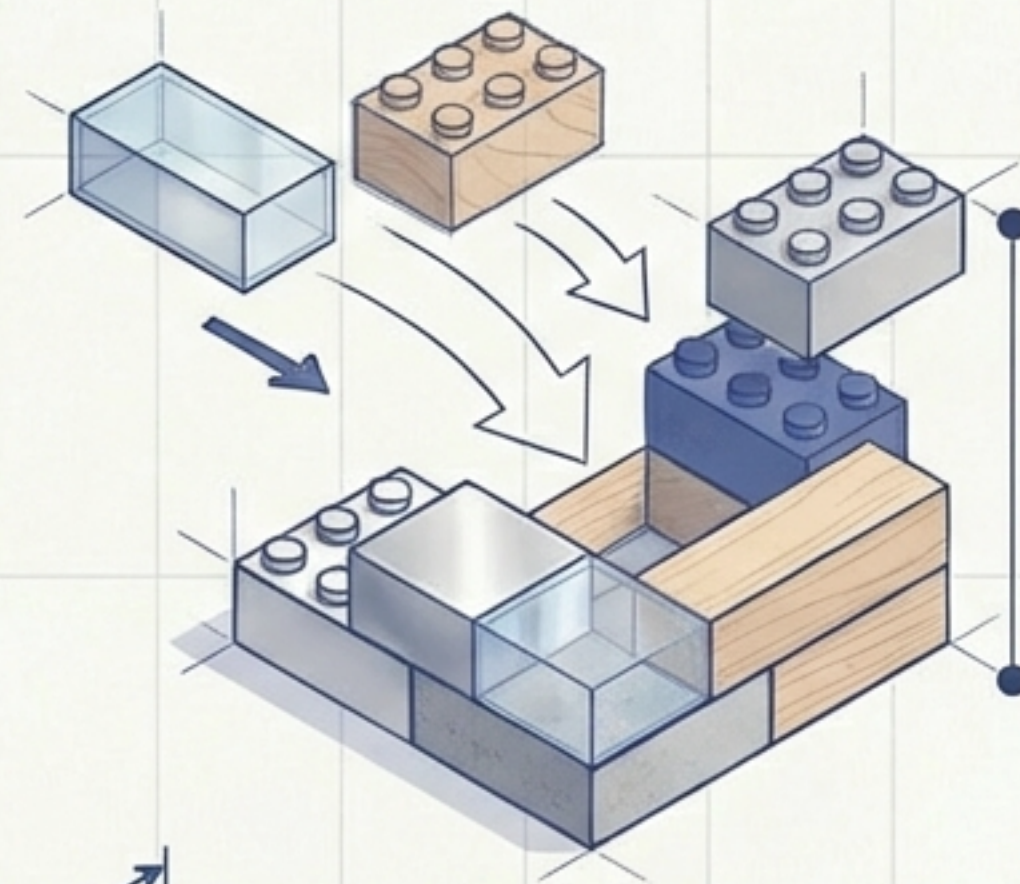

Lo Strumento:  
**L'Editor a Blocchi**  
**(Gutenberg)**



Paragrafo

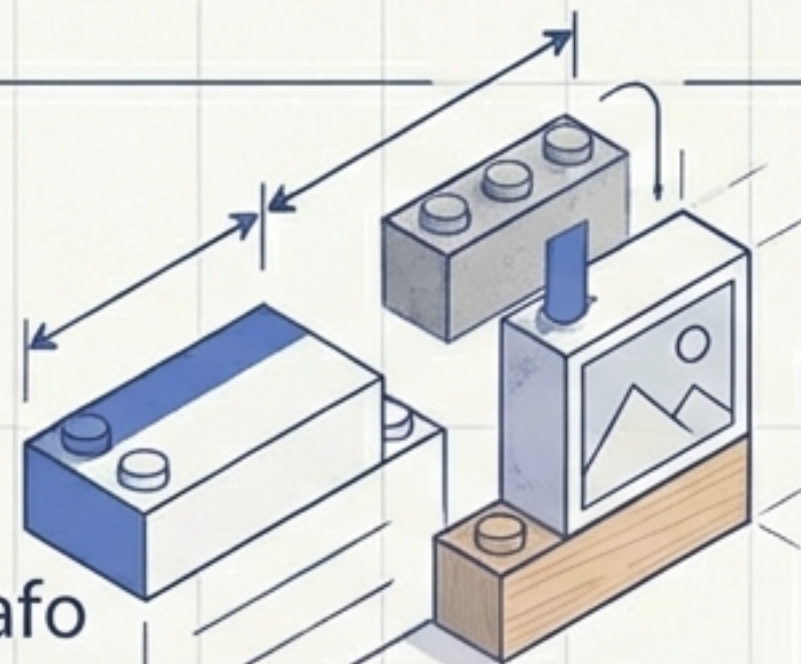

Immagine

# Design e Arredamento

Il **TEMA** determina il look del tuo sito.



Vai su **Aspetto > Temi** per iniziare. →

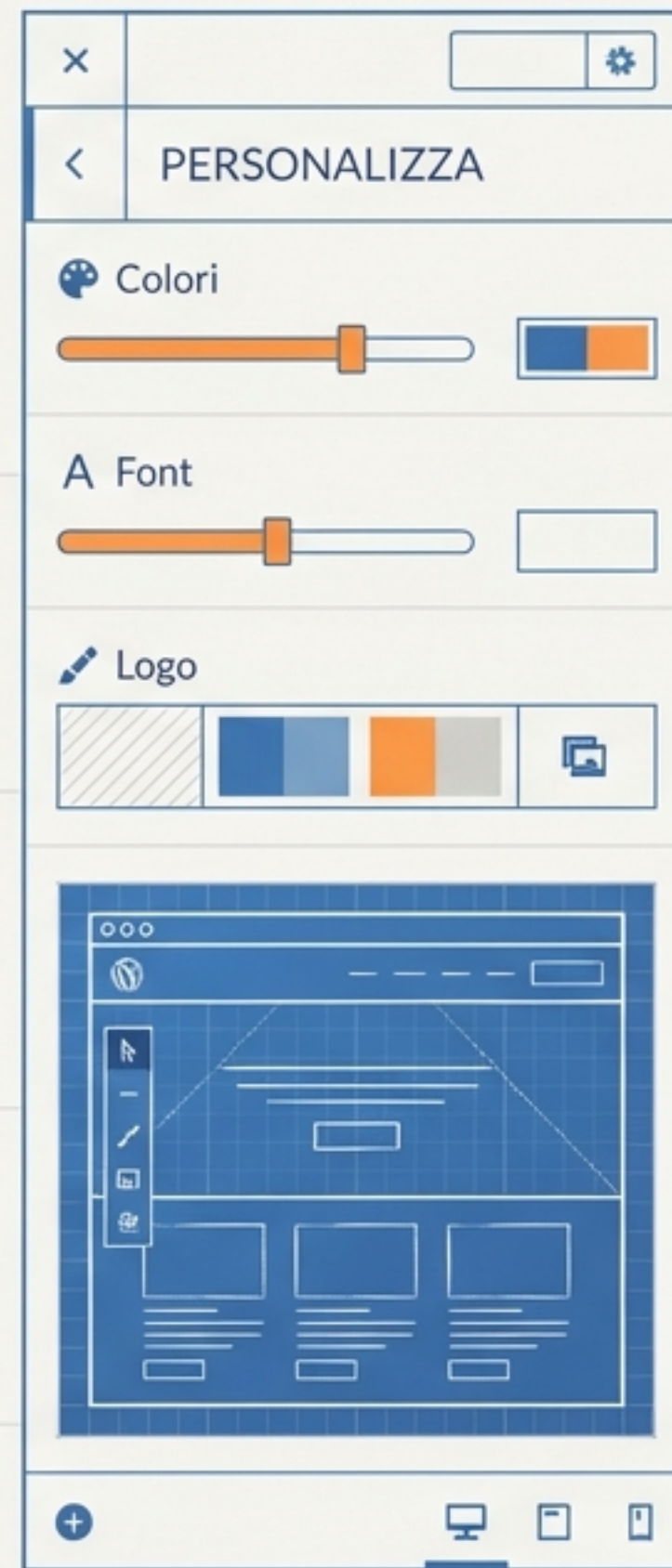

# Elettricità e Impianti (Plugin)

I Plugin aggiungono funzionalità che WordPress non ha di base.

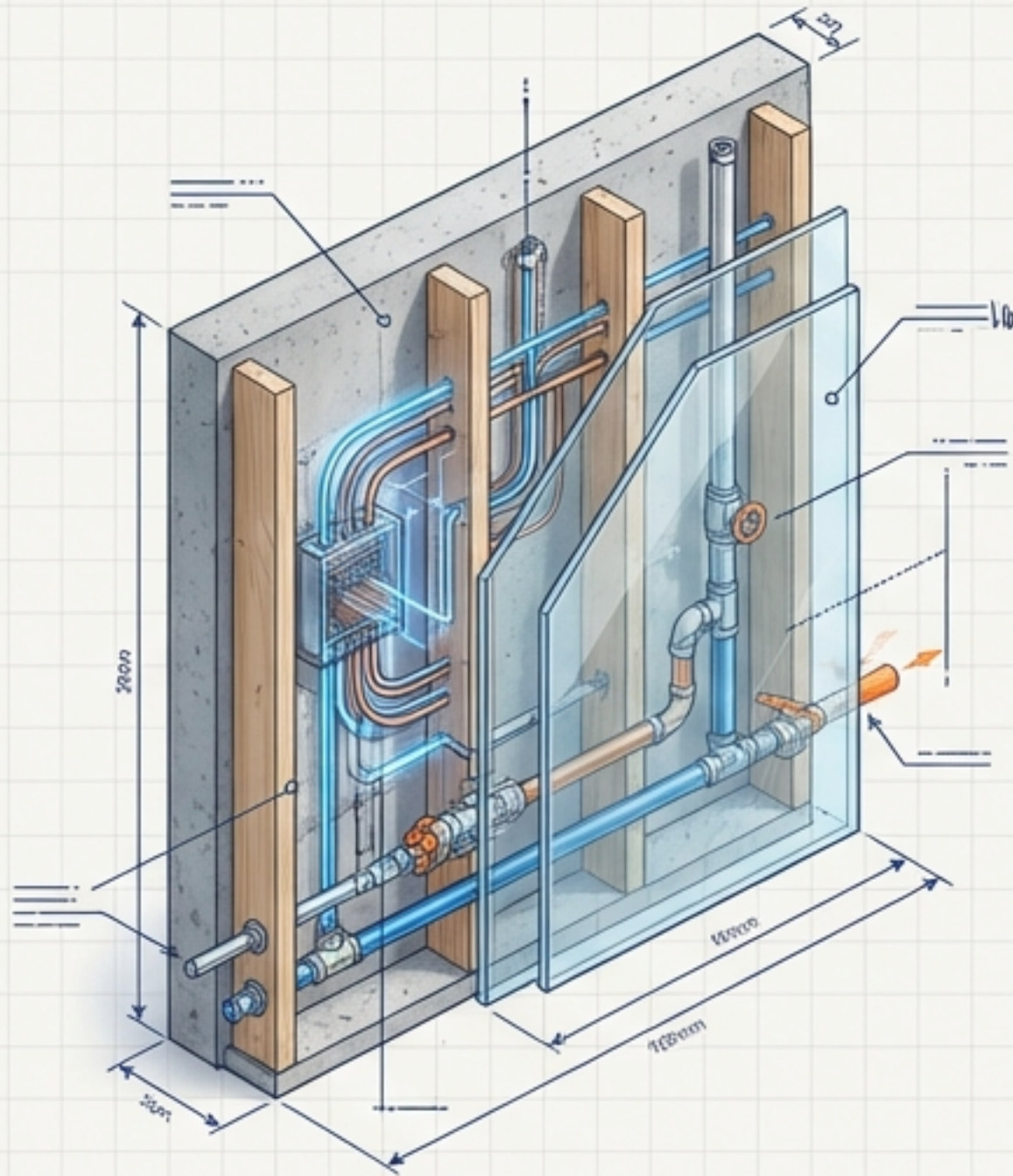

Cerca



Installa ora



**Attiva**



# La cassetta degli attrezzi indispensabile

Gli strumenti essenziali per costruire, proteggere e far crescere il tuo sito WordPress.



# Farsi trovare sulla mappa (SEO)



200

69

216

## Yoast SEO

- **Semaforo Verde**
- ✓ - **Titolo SEO:** Max 60 caratteri + Parola Chiave
- ✓ - **Meta Description:** Il “trailer” del tuo contenuto (155 caratteri)
- ✓ - **URL:** Brevi e **puliti** (niente codici)
- ✓ - **Immagini:** Inserisci sempre il **Testo alternativo** (Alt Text)

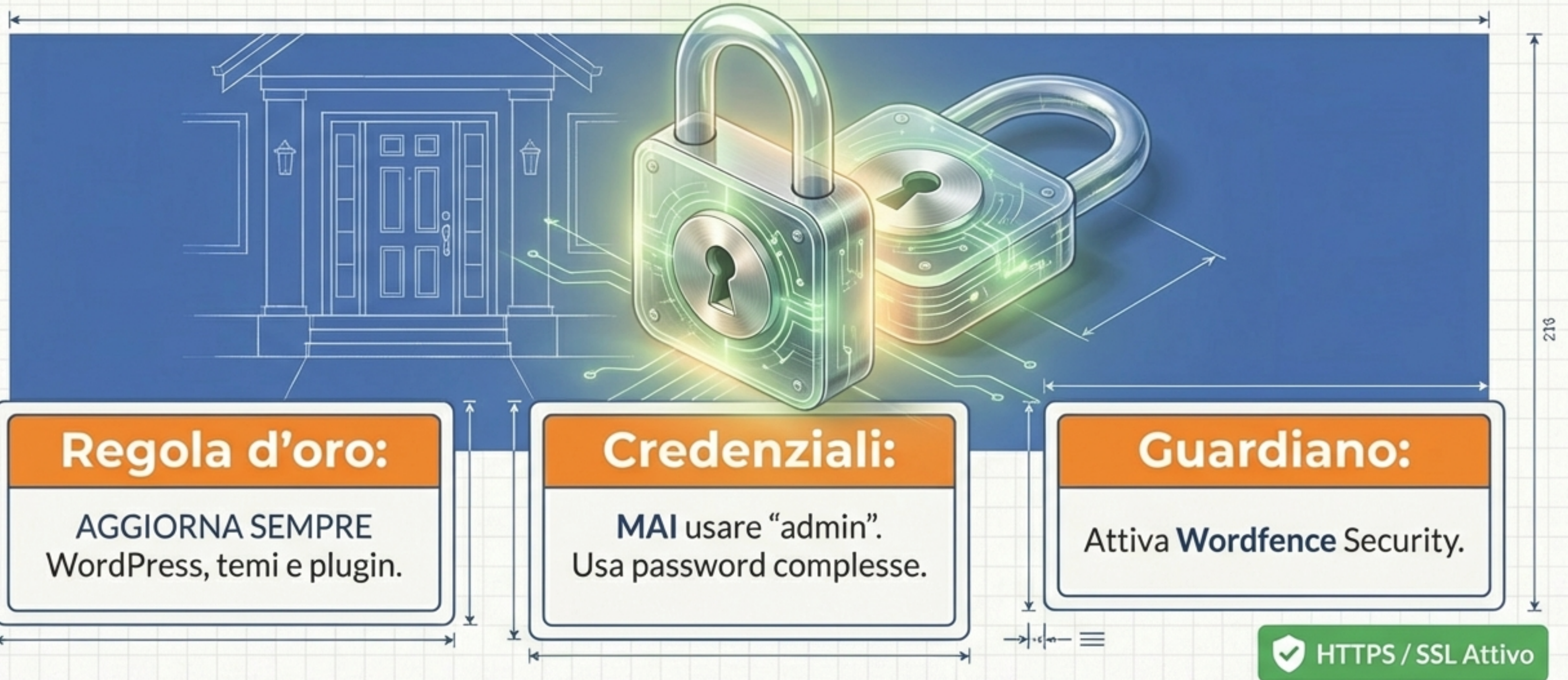

≡

# Blindare porte e finestre

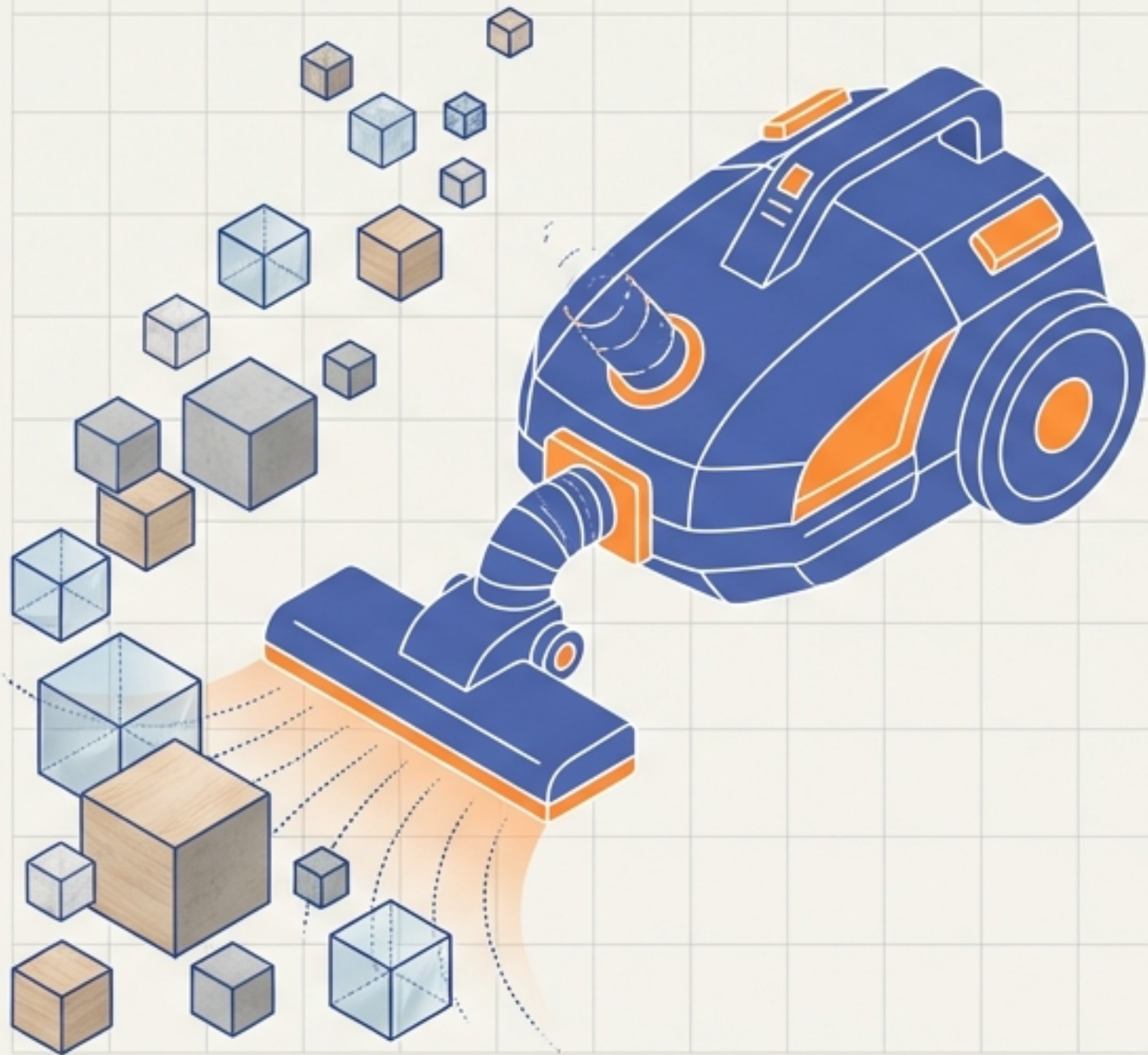

# Pulizie di primavera



150 <b>Media</b>	<b>Usa SMUSH</b> per comprimere le immagini automaticamente.	90 
216 <b>Database</b>	<b>Usa WP-OPTIMIZE</b> per rimuovere i dati vecchi.	
216 <b>Routine Settimanale</b>	<b>Verifica</b> aggiornamenti e controlla i backup ( <b>UpdraftPlus</b> ).	

# Una casa veloce e scattante

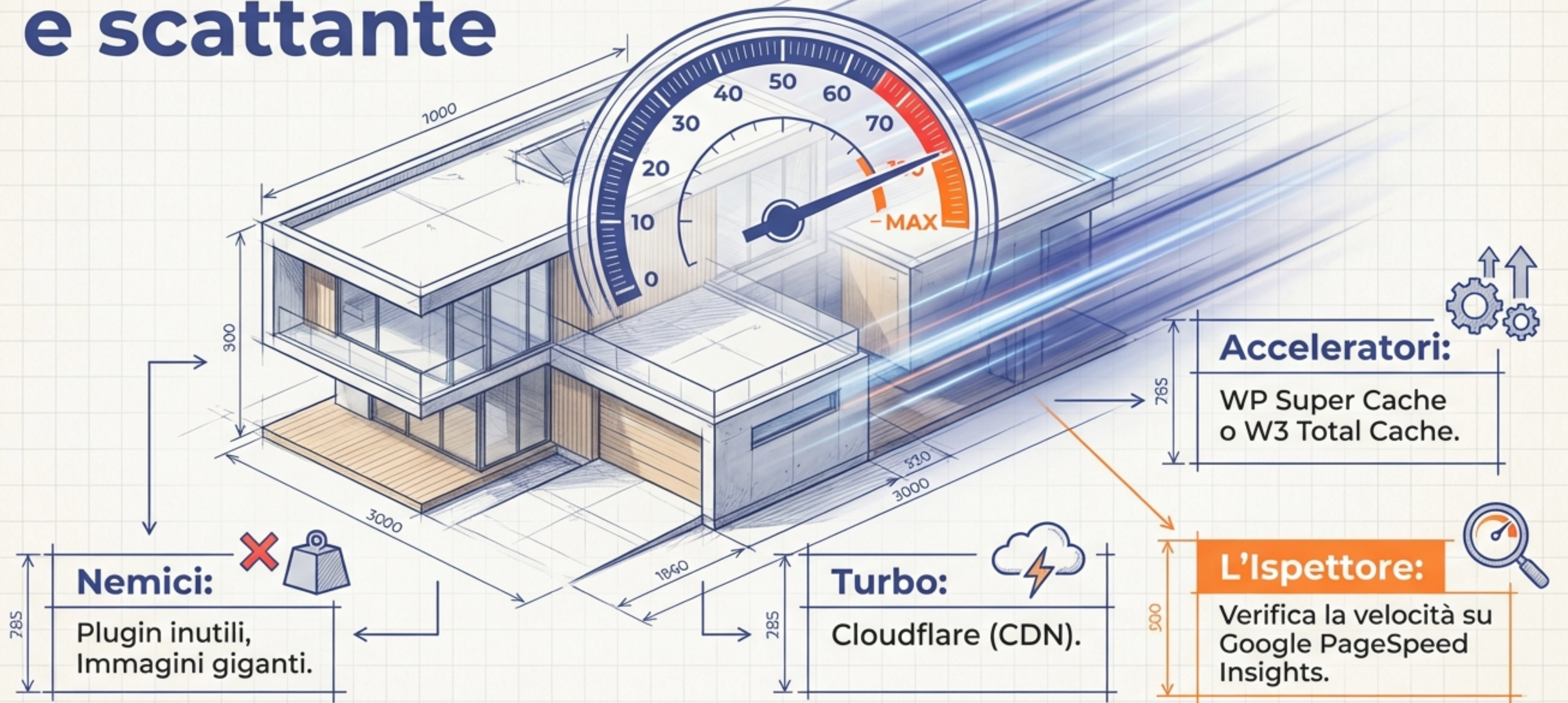

# Non sei solo nel quartiere



## **Ufficiali:**

WordPress.org  
Codex & Support  
Forum



## **Italia:**

Forum WordPress  
Italia & Gruppi  
Facebook



## **Tutorial:**

WPBeginner &  
YouTube

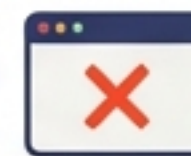

## **SOS:**

Schermata bianca?  
Disattiva i plugin  
via FTP.

# Le chiavi sono tue.

## Recap

1. Configura impostazioni.
2. Scegli tema.
3. Installa plugin essenziali.
4. Pubblica il primo contenuto.



Non aver paura di provare. Puoi sempre ripristinare da un backup.

